





1-800-BOLLARDS

The Bollard Experts

- SELECT DESIRED MATERIAL:
(12" NOMINAL SIZE)
 - BSS012000 SCH 10 STAINLESS STEEL
 - BSS012040 SCH 40 STAINLESS STEEL
 - BSS012080 SCH 80 STAINLESS STEEL
 - BCS012040 SCH 40 ASTM A-53 CARBON STEEL
 - BCS012080 SCH 80 ASTM A-53 CARBON STEEL
- SELECT DESIRED STAINLESS STEEL BOLLARD FINISH:
 - POLISHED #4 FINISH
 - AS SPECIFIED _____
- SELECT DESIRED CARBON STEEL BOLLARD FINISH:
 - POWDER COAT RAL # _____
 - AS SPECIFIED _____
- SELECT DESIRED STAINLESS STEEL BOLLARD MATERIAL:
 - TYPE 304
 - TYPE 316
- SELECT DESIRED BOLLARD CAP STYLE:
 -  DOME (SHOWN)
 -  STANDARD FLAT
 -  REVEAL
 -  SLOPED

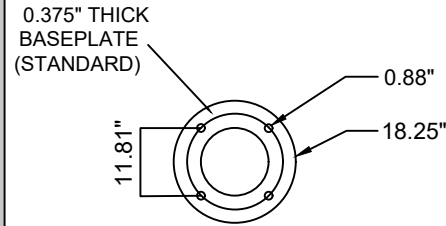
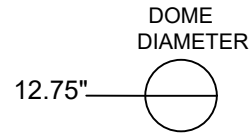
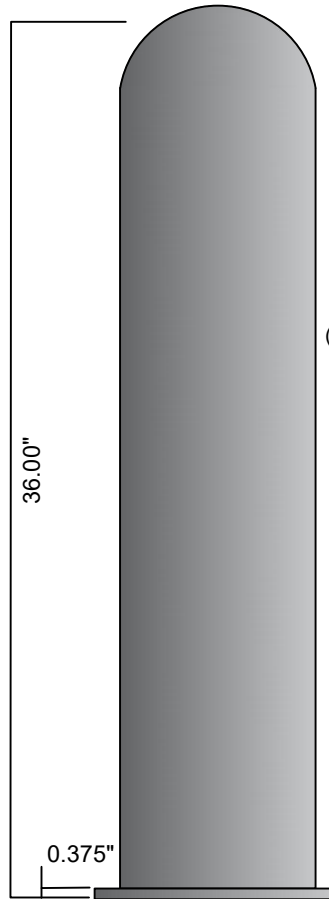

PLAN VIEW - BASE PLATE
(USED ON STAINLESS STEEL BOLLARD)

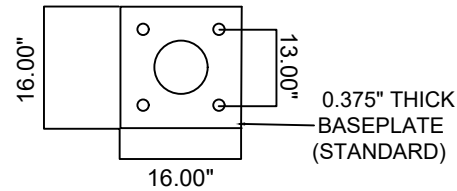

PLAN VIEW - BASE PLATE
(USED ON CARBON STEEL BOLLARD)

ALTERNATE INSTALL METHOD

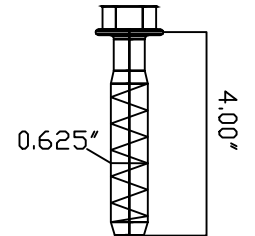

BASE PLATE REQUIRES
(4) 0.625" X 4" ANCHOR BOLTS
OR CINCH ANCHORS
BY OTHERS

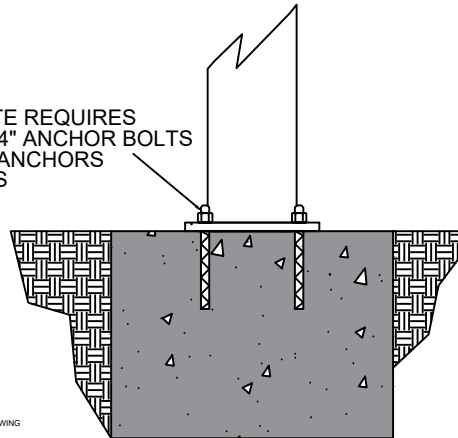

END VIEW - FOUNDATION

DOME (SHOWN) STANDARD FLAT REVEAL SLOPED

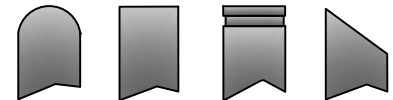

NOTES:
 1. INSTALLATION TO BE COMPLETED IN ACCORDANCE WITH MANUFACTURER'S SPECIFICATIONS.
 2. DO NOT SCALE DRAWING.
 3. THIS DRAWING IS INTENDED FOR USE BY ARCHITECTS, ENGINEERS, CONTRACTORS, CONSULTANTS AND DESIGN PROFESSIONALS FOR PLANNING PURPOSES ONLY. THIS DRAWING MAY NOT BE USED FOR CONSTRUCTION.
 4. ALL INFORMATION CONTAINED HEREIN WAS CURRENT AT THE TIME OF DEVELOPMENT BUT MUST BE REVIEWED AND APPROVED BY THE PRODUCT MANUFACTURER TO BE CONSIDERED ACCURATE.
 5. CONTRACTOR'S NOTE: FOR PRODUCT AND COMPANY INFORMATION VISIT www.CADdetails.com/info AND ENTER REFERENCE NUMBER 5046-027.

REVISIONS			
LTR	DESCRIPTION	DATE	APPVD
COMMENTS			
SPECIFICATIONS			
HEIGHT: 36"			
DIAMETER: 12.75"			
WALL THICKNESS: 0.280" SCHED 40			

APPLICATION		PRODUCT SUB LINE	TITLE
NEXT ASSY	USED ON	1-800-BOLLARDS, Inc. 10 Hughes Suite A105 Irvine, CA 92618 PHONE: 1-800-BOLLARDS WEB: www.1800BOLLARDS.COM EMAIL: info@1800BOLLARDS.COM	BOLLARD, BASEPLATE
SERIES NUMBER: YX-S060-XX		CAGE CODE: 6NGJB	REV: 6th Cutsheet Size A - R1
PRODUCT FAMILY: FIXED BOLLARD		DRAWN BY: AJA	DRAWING REV:
PRODUCT CLASS: STANDARD OR CUSTOMER DEFINED		CHECKED BY:	SHEET: 1 OF 1
PRODUCT LINE: BOLLARD		APPROVED BY:	RELEASE DATE: